

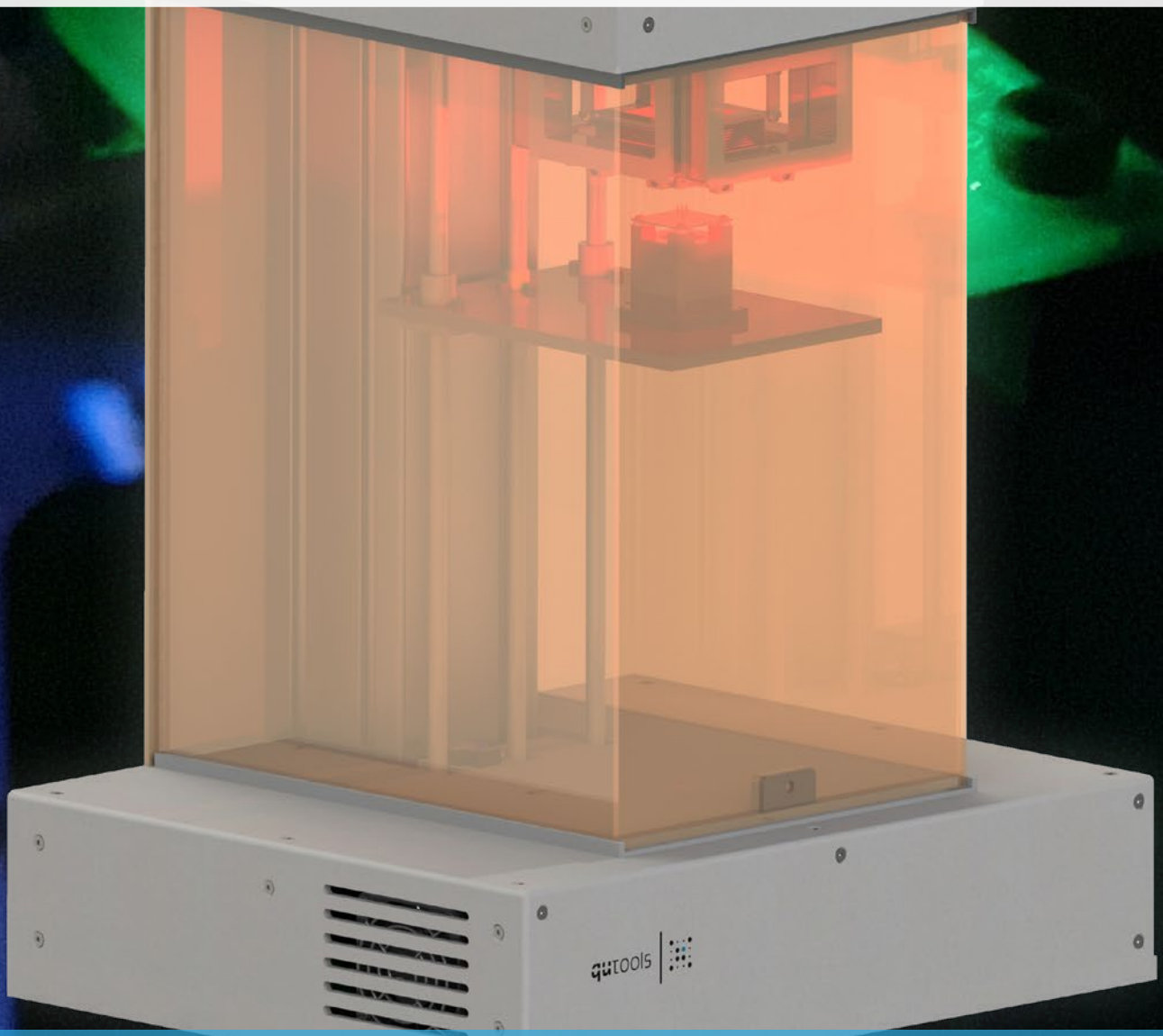

quNV – NV Center Sensing Quantum Sensing Education Kit



Quantum Sensing by Diamond
Magnetic field sensing , Electron Spin Manipulation, ODMR

Quantum Physics Revolution

The advances in research of the last two to three decades have led to the second quantum revolution with applications and technologies based on principles of quantum mechanics.

Lasers, magnetic resonance imaging and semiconductors are three technologies based on quantum physics that had a significant impact on our lives for more than half a century. Nowadays, the emergence of second-generation quantum technologies brings a new wave of applications to everyone's lives.

Second-Generation Quantum Technologies

The most discussed fields are quantum computers, considered to have high disruptive potential in the capabilities of modern supercomputers. Another field is quantum communication which may change the architecture of today's IT security infrastructure. Finally, the field quantum sensing, imaging and metrology is emerging by research, development and new applications.

One promising quantum platform for all these fields are nitrogen-vacancy (NV) centers. The electron spin of the NV center can be easily manipulated at ambient conditions by magnetic and electric fields, microwave radiation, and light, leading to a variety of applications.

Nitrogen-Vacancy Centers

Carbon forms, in one of the allotropes, a cubic lattice, called diamond. Within the diamond lattice numerous types of defects can exist. One of these defects is the nitrogen-vacancy center. It is formed by a substitutional nitrogen atom associated with a neighboring vacancy in the diamond crystal structure.

The NV center can be excited by light in the visible spectrum. The excited state decays back to the ground state either directly or via an intermediate shelving state with different fluorescence intensity. The decay path depends on the electron spin of the NV center.

This allows optical readout and initialization at room temperature. Further the electron spin can be manipulated by microwave radiation. Applying magnetic and electric fields the energy levels of the spins can be shifted. Hence, a vast amount of experiments and measurement applications are possible.



The NV center can be used as a quantum sensor for very sensitive magnetic field measurements.

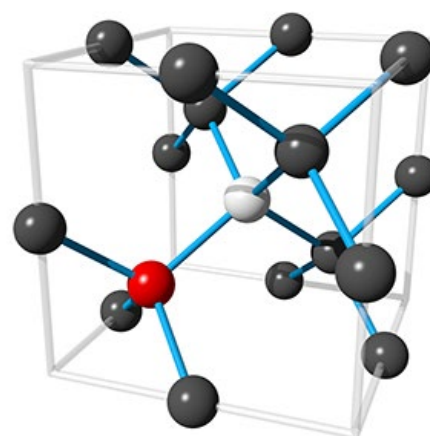

NV centers consist of a nitrogen atom (red) next to a vacancy (white) in a carbon (gray) cubic lattice.

Electron Spin Manipulation

Applying microwave radiation with 2.87 GHz to the NV center drives the transition between $m_s = 0$ and ± 1 in its electronic ground state. Additional excitation with laser light in the green spectrum populates $m_s = \pm 1$ in the electronic excited state.

This state has a significant possibility of intersystem crossing from 3E to the shelving state 1A with a long lifetime. From there it decays with high probability back to the $m_s = 0$ ground state. Due to the longer lifetime, the fluorescence gets quenched by applying microwave radiation at the frequency D , resonant to the transition between the spin levels. Hence, the fluorescence of a NV center is brighter when it is in the $m_s = 0$ state.

Applying a magnetic field B , the $m_s = \pm 1$ levels of the ground state split up linearly according to the Zeeman effect. Thus, the microwave resonance frequency also shifts. This allows measurements of magnetic fields with high sensitivity and high spatial resolution.

The dynamics of the NV center allow applications like spin initialization and state readout. Therefore, the center is suitable for quantum sensing applications like magnetic field sensing, spin relaxation time measurements and optically detected magnetic resonance - ODMR.

Applications and Education

The quNV science kit enables experiencing the properties of nitrogen vacancy centers in diamonds. The applications of the quNV are student lab course experiments, demonstration experiments in lectures, hands-on experiments for science centers and project kits for students' research centers.

It enables the user to conduct experiments like electron spin manipulation, ODMR and magnetic field sensing of different samples.

The quNV can also be enhanced to locate and manipulate a single NV center in a prepared diamond, measure the $g^{(2)}$ Function to prove that the emitted photons cannot be split up and that an NV center is a source of real single photons and even upgraded to a microscope for magnetic analysis of different geological or biological samples.

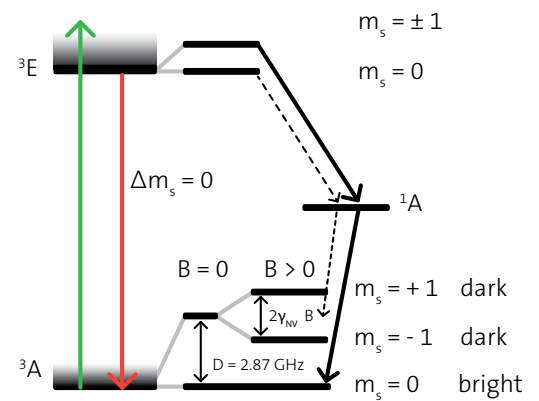

Energy-level scheme of the NV center. A green laser excites the NV center to the 3E state, from where it either decays to 3A or undergoes intersystem crossing to the metastable state 1A , before decaying to the $m_s = 0$ ground state.

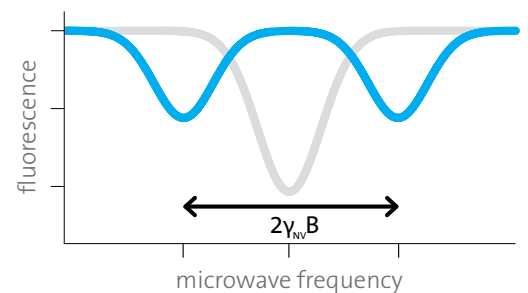

The gray curve shows the decrease of fluorescence at the resonance frequency. The $m_s = \pm 1$ ground level of the NV center splits up linearly by applying a magnetic field (blue) and indicate the shift in the resonance frequencies.

quNV - Quantum Sensing by NV-Centers

The quNV is a compact and user-friendly quantum physics kit to experience quantum photonic effects in nitrogen vacancy centers in diamond.

Quantum Physics

quNV is a quantum diamond magnetometer and will introduce students to the concepts of quantum sensing. It is based on recent achievements of scientific research and demonstrates quantum sensing for student lab courses at colleges and universities.

Experiments

The quNV science kit enables experiencing the properties of nitrogen vacancy centers in diamonds. It enables the user to conduct experiments like NV center fluorescence, electron spin manipulation, optically detected magnetic resonance and magnetic field sensing of samples.

Compact Design

The device comes in a compact design suited for a lab table or lecture hall with the optics enclosed on top and the electronics in the base of the device. The NV centers in the diamond and the probe on a stage are encapsulated by acrylic glass to ensure laser safety.

Upgradeable

The core elements of the quNV are designed to be enhanced by multiple upgrades and features. It is possible to include a CMOS sensor for microscope imaging, different objectives, single photon detectors and time tagging electronics to perform experiments with single NV centers.

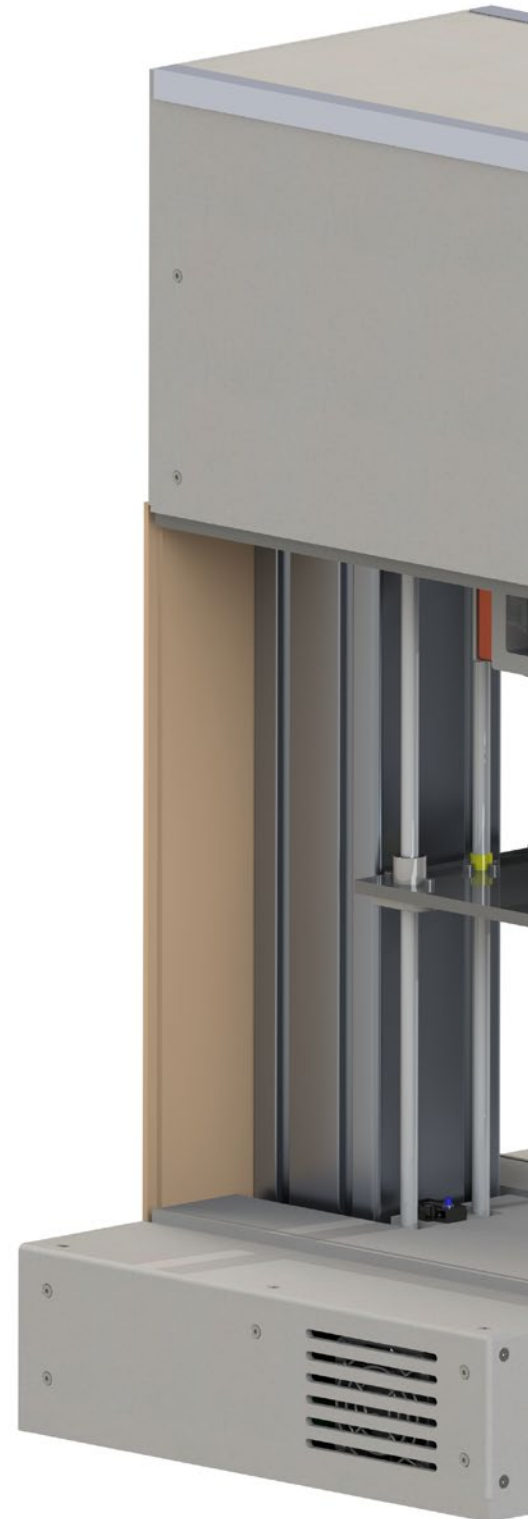

Digital Electronics

The whole setup is controlled by modern digital electronics in the base of the device. The excitation laser and the microwave source can be pulsed, the photodiode gated. Also the magnetic field and all stages for sample positioning are controlled via USB or Ethernet by the user.



Laser Optics

All optics are housed in the upper part of the device. The laser, a telescope and two mirrors for proper alignment, a dichroic mirror for splitting the green laser and the red fluorescence are mounted in front of the fast photodiode, shielded by a bandpass filter in the red spectrum.

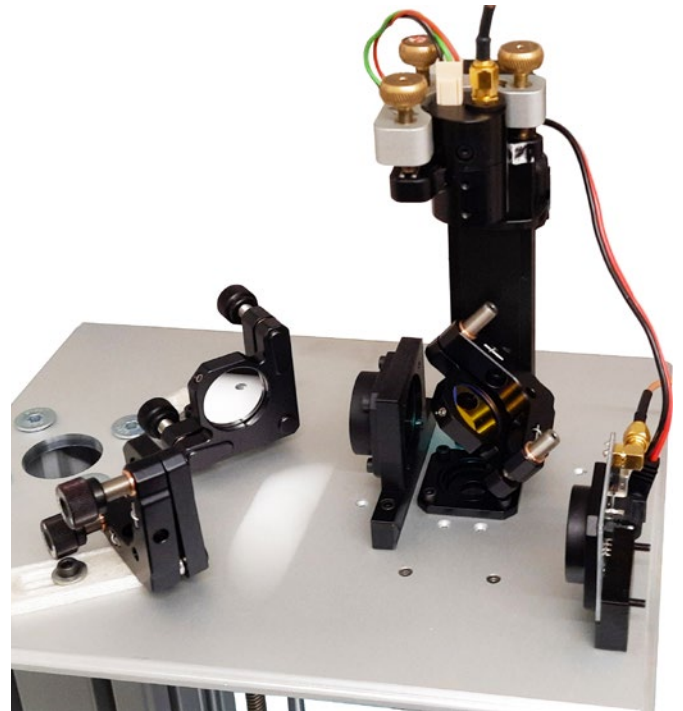

Helmholtz Coils

The diamond including the NV centers are in the center of three Helmholtz coils. These coils generate a magnetic bias field for the NV centers. All three coils can be individually controlled to gain the desired bias field in three dimensions or counter the earth's magnetic field.

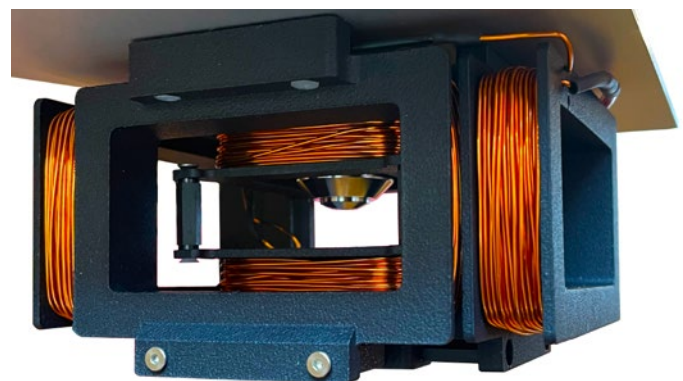

quNV - Core Components

The quNV is based on recent achievements of scientific research and demonstrates quantum sensing for student lab courses.

The core of the base quNV is a HPHT diamond with an ensemble of nitrogen-vacancy (NV) centers. The NV centers can be excited by light in the visible spectrum. The excited state decays back to the ground state directly or via an intermediate shelving state with different fluorescence intensity. The decay path depends on the electron spin of the NV centers. Thus, the electron spin can be read out optically.

The electron spin can be manipulated further by microwave radiation. By applying magnetic and electric fields, the energy levels of the spins can be shifted. Hence, different experiments and measurement applications are possible.

The following core components are designed to perfectly interact together, forming the heart of the quantum physics kit quNV.

Laser Excitation

The NV centers are excited by a powerful 100mW continuous wave laser with a wavelength of 520nm. The laser is collimated and expanded to create optimal conditions for the following microscope objective. The objective focuses the laser light onto the nitrogen-doped diamond.

Diamond Sample Stack

The laser spot focused by the objective hits the diamond, which is built into a circuit board. The microwave antenna is also integrated in the circuit board. It is mounted on a stack to which the specimen itself is attached. The circuit board with the antenna and the diamond can be replaced by other boards with different diamonds, depending on the experiment.

Microwave Sweep and Pulse

The microwave radiation is emitted by the antenna within the circuit board. It is controlled by electronic components in the base of the quNV. The microwave can be varied in amplitude, swept in frequency and even pulsed.

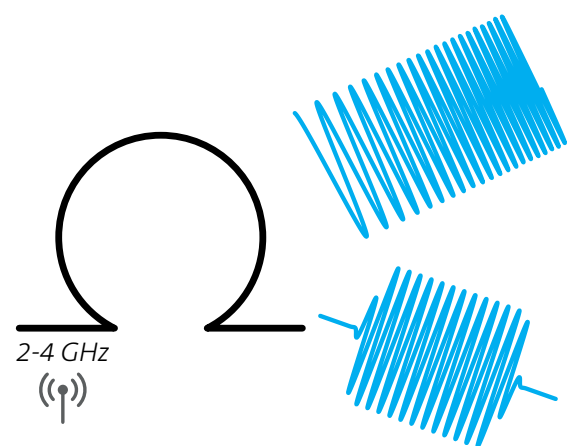
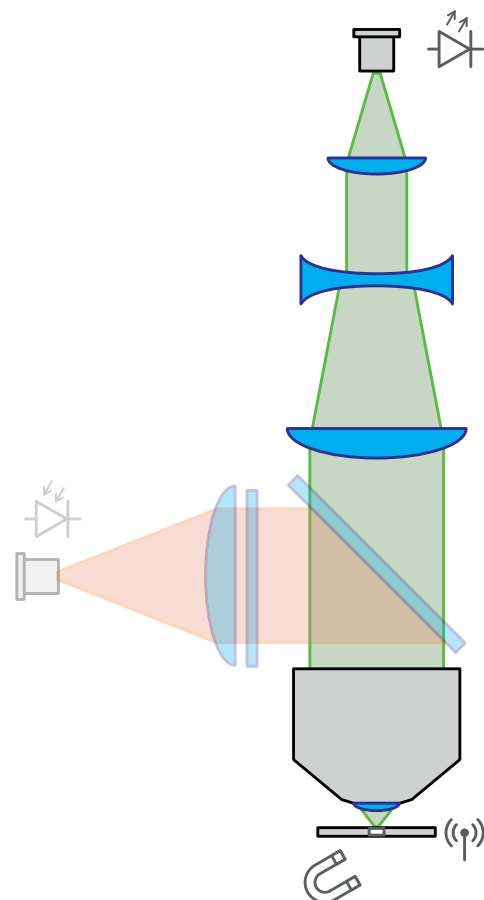

Helmholtz Coils

The three Helmholtz coils surround the sample stack. These three coils generate a homogeneous magnetic field as a bias for the NV centers. All three coils can also be controlled individually to adjust the field in three dimensions. The coils are equipped with temperature monitoring sensors for safety reasons.

Pattern Generator

The electronics in the base of the quNV also includes a pattern generator. This pattern generator can control and pulse the laser, the microwave and the photodiode for fluorescence readout. Different pulse patterns can be applied to all three components with the desired time intervals in between. The cw laser can be pulsed for excitation and readout, the microwave for the emission of π and $\pi/2$ pulses and the photodiode gated.

Photodiode

The fluorescence from the excited NV center is also collected by the microscope objective and returned to the unit on top of the instrument by the same optical path. There, the red fluorescence is separated from the green excitation laser by a dichroic mirror. After two mirrors for proper alignment, the fluorescence is filtered by a bandpass to measure only the red fluorescence rather than the excitation laser nor the environment. In the end, the light is focused on the active region of the fast photodiode.

Measurement

In a basic measurement, a magnetic bias field by the Helmholtz coils is set. Then the laser excites the NV centers in the diamond, which fluoresce in the red spectrum. That light is detected by the photodiode. Now the microwave frequency is swept. Plotting this frequency versus the fluorescence intensity shows the resonance frequencies of the NV centers.

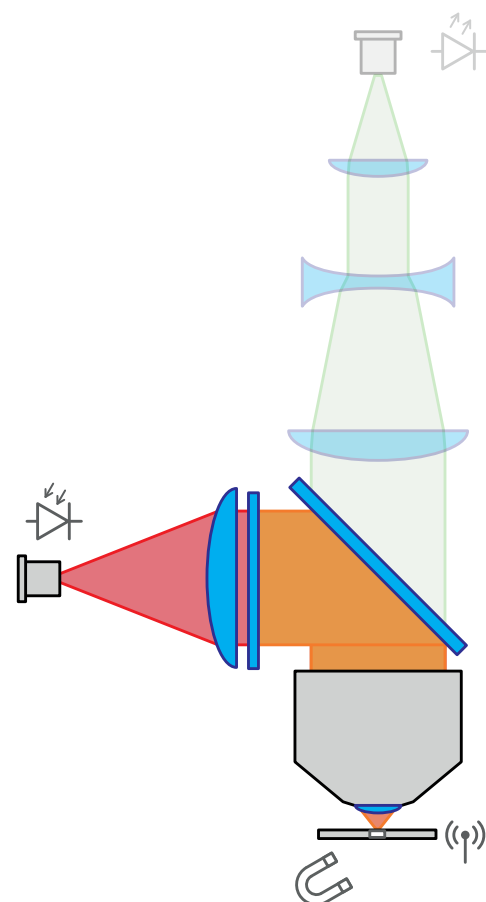
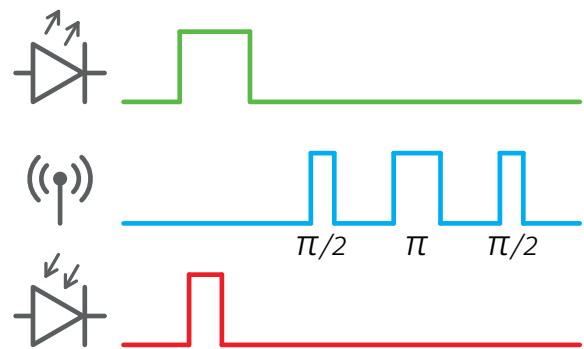
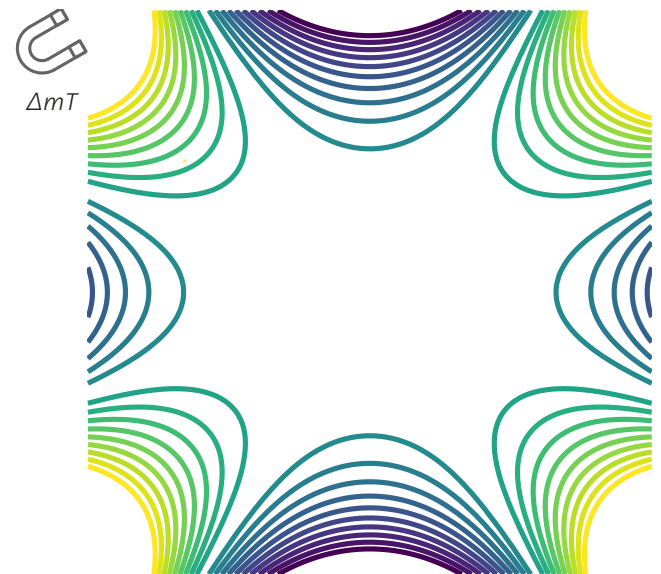

quNV - Variants and Upgrades

The core unit of the NV quantum sensing kit can be further supplemented and upgraded to either perform experiments with a single NV center or use the setup as a full quantum microscope.

For every variant, some components of the base system have to be exchanged for ones better suited for the purpose. For example, the objective and optical part has to be exchanged for each variant, so these are not upgrades that can be made in the field. On the other hand, the HBT upgrade or the Sensing Kit can be added to a functional system later.

Microscopy Variant

This variant will allow you to take a deeper look at the application of NV center microscopy for magnetic analysis of different samples, e.g., geological or biological.

Doped Diamonds

At the heart of the microscopy variant, there is a chemically pure CVD diamond with a uniform distribution of NV centers right below the surface of the diamond in order to best couple them to the magnetic properties of your sample.

Camera

Instead of a photodiode or the APD of the single photon variant, a camera can be used to achieve a wide field of view of the diamond and sample at once. One can then show how an ODMR measurement can be performed on this field of view to determine the magnetic field at every point at once.

Sensing Kit

Try out the effect a differently doped diamond can have and use them to perform microscopic measurements on different samples.

Doped Diamonds

A selection of diamonds doped in different depth layers and with a varying concentration of NV centers pointing in different directions.

Objectives

An objective with the desired magnitude and the matching optical setup will complete the arrangement for microscope images of magnetic fields.

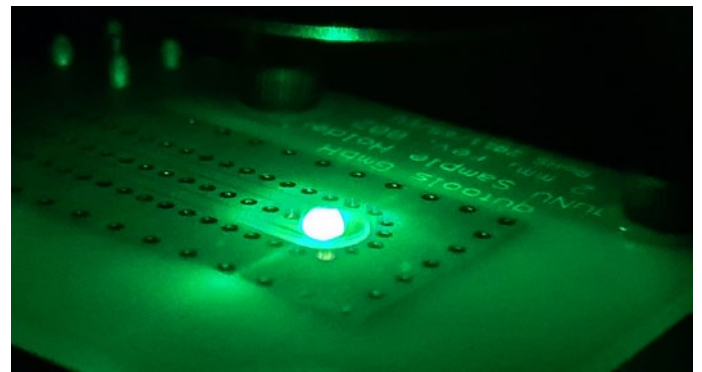

Various doped diamonds are available for the different samples and experimental setups.

Samples

Different cut and polished rock samples showing interesting magnetic properties from the field of geology.

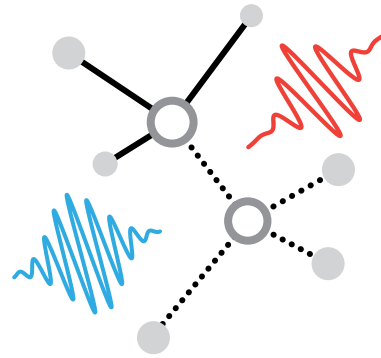

Single Photon Variant

With this variant you'll obtain the ability to locate and manipulate a single NV center in a specially prepared diamond.

Diamond Samples

Specially made chemically pure CVD-Diamonds with an ultra-low concentration of NV centers are at the core of this variant to ensure single and isolated NV centers in the focal spot.

Piezo Stages

High precision piezo stages allow for precise control and scanning of the viewing area in order to find a defect and stay focused on it.

HBT Upgrade

Measure the $g^{(2)}$ Function to prove that the emitted photons cannot be split up and that an NV center is a source of real single photons.

Fiber Beam Splitter

The single photons are led to a beam splitter to try and split them up.

Additional Single Photon Detector

With an additional single photon detector, one can make measurements on the photon statistics of the emitted photons.

High NA Confocal Microscope

A high NA objective and the following confocal microscope setup make it possible to couple a high percentage of emitted fluorescence photons into a fiber leading to the detectors.

Single Photon Detectors

A fiber based high efficiency avalanche photodiode with a sharp time resolution rounds up the system.

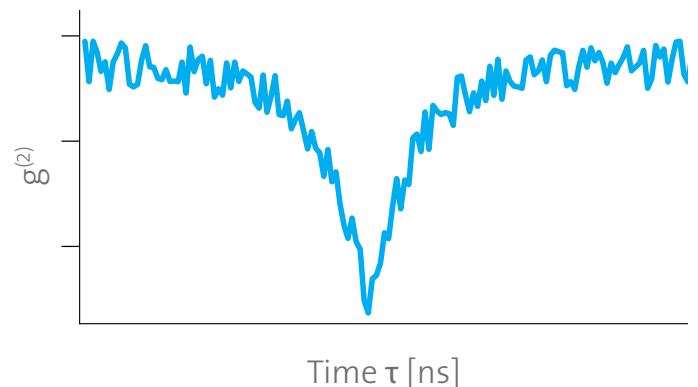

Autocorrelation data of the single NV center recorded with a single photon detector and time-correlated single photon counting electronics.

Picosecond Timing Resolution

With technology borrowed from our quTAG time tagger series, the APD signals can be analyzed down to the picosecond time domain to show a high resolution $g^{(2)}$ dip.

quNV - Sample Experiments

Experience the properties of nitrogen vacancy centers in diamonds. Multiple experiments enable the user to conduct electron spin manipulation, ODMR and magnetic field sensing of different samples.

Rabi Oscillations

When you expose an NV center to an alternating electromagnetic field in the microwave frequency range, the transition between the $m_s = 0$ and the $m_s = \pm 1$ ground states are driven. If you start with an ensemble initialized to the $m_s = 0$ state, the system will begin to oscillate between the different states. This phenomenon is called Rabi oscillation, the cyclic behavior of a two-level quantum system in an oscillatory driving field.

Experiment Setup

Before the experiment, one needs to determine the exact frequency of the microwave. The goal is to drive the transition as efficient as possible. Therefore, one first performs a standard ODMR measurement sweep.

With the green laser turned on, the photodiode intensity is recorded while the microwave frequency is tuned. The intensity will be lowest at the frequencies that drive the transition most effectively, since the $m_s = \pm 1$ states appear darker than the $m_s = 0$ state.

Observing Rabi Oscillation

Of course, the green laser will immediately destroy the state of the NV center we are looking at, so we can't directly observe any time evolution. We can, however, observe the state at any given time and then start over for the next measurement. If we vary the time delays until the state is read out again, and we assume that the state evolution happens in the same way each time, we can "watch" the process unfold!

The Rabi experiment also lays the groundwork for other experiments, exploring the quantum nature of NV centers even further. Can you imagine what you can do with the results? Can this two-state quantum system be used to model a qubit?

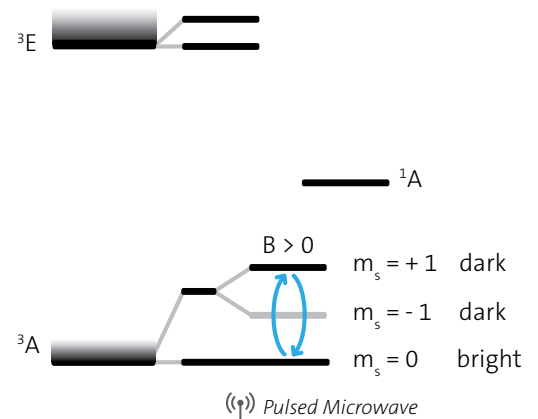

Energy-level scheme of the NV center with Rabi oscillations between $m_s = 0$ and $m_s = +1$ state.

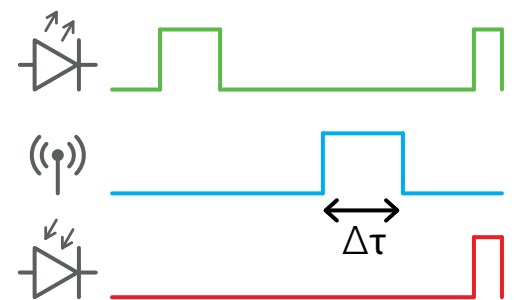

Pulse schematic of laser with excitation and read out (green), microwave (blue) at a fixed frequency and the gated read out time of the photodiode (red).

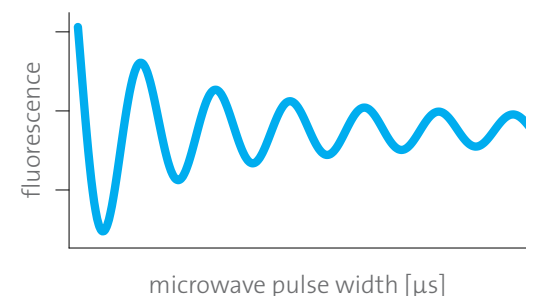

Rabi oscillation measurement with varying pulse length τ of the microwave. The fluorescence intensity of the NV center is proportional to the population of the $m_s = 0$ state.

ODMR Microscopy

With ODMR microscopy, one can measure the magnetic field present in a whole area with a high resolution in order to analyze a certain sample, e.g., geological samples containing magnetic material, or biological samples containing magnetotactic bacteria.

Experiment Setup

In order to get the spatial resolution, a diamond with a very defined distribution of NV centers right next to the surface is used in combination with imaging optics and a CCD camera. By using diamonds with implanted NV centers at varying depths, one can explore the impact of distance between sample and sensor.

The sample has to be placed directly on the surface of the diamond to make sure this distance is equal throughout the field of view.

Also, in order to be able to resolve small changes in the magnetic field and therefore the magnetic properties of the samples, one needs to apply a constant magnetic field called the bias field.

Calculating the pseudo-color plot

With that configuration, one can extract all the necessary information in order to calculate a pseudo-color plot that shows the magnetic properties of the sample. For each pixel, the ODMR spectrum is measured by sweeping the microwave frequency while measuring the brightness of the pixel. From the position of the dips, one can then determine direction and strength of the magnetic field at the NV center site by fitting the data. The bias field strength can be subtracted in order to obtain the effect that the magnetic sample has on the spectrum, locally.

This approach can of course be generalized to a pulsed ODMR measurement scheme or any other pulsed scheme in order to maximize sensitivity.

What other experiment can you imagine using the hardware? Which samples would you like to analyze?

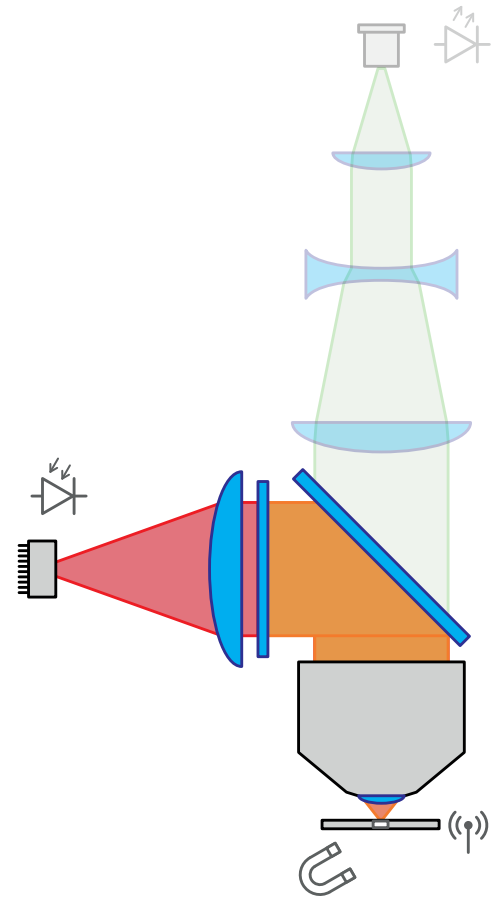

The optical setup changes by a camera, the tube lens and the objective. It is used to achieve a wide field of view of the diamond and sample at once.

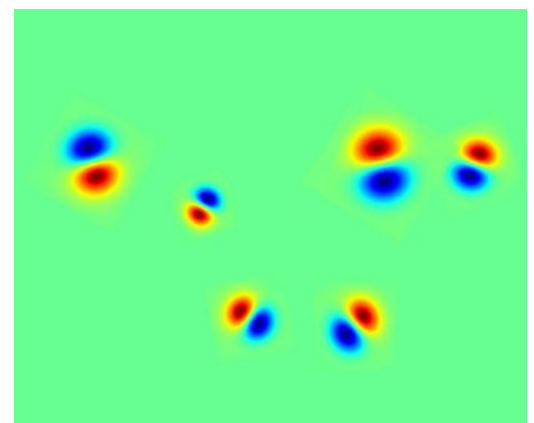

Magnetic field distribution in a false color plot of dipoles.

Further Science Kits

Qutools quantum physics kits for education

Quantum Physics in Teaching

The **Quantenkoffer** is a portable and user-friendly quantum photonics laboratory for a multitude of experiments from 100 years of quantum physics.

The key feature is its flexibility with regard to generation and detection of visible laser light, single photons and even entangled pairs. Its optical elements, mechanical components and digital circuits are integrated in order to cover a range of experiments and topics of quantum physics as wide as possible.



Entanglement Demonstrator for Physics Courses

The **quED** design combines recent achievements of quantum optics technology into an easy-to-use system for academic, research and applied purposes with precise accuracy. Advanced models for scientific purposes are available as well, with a high performance meeting the requirements of state-of-the-art physics experiments.

qutools' Entanglement Demonstrator is designed with educators in mind. It's the easiest and most reliable way to explain the complex phenomena of quantum mechanics by generating and analyzing polarization-entangled photon pairs.



qutools GmbH

Kistlerhofstraße 70, Geb. 88
81379 München, Germany

Phone: +49 89 32164959-0

Email: info@qutools.com

Web: www.qutools.com