



## FEATURES

- Superior extinction ratio: 40 dB
- High bandwidth
- X-cut for high stability
- Low drive voltage
- Low insertion loss

## APPLICATIONS

- Pulse generation / picking
- Carrier suppression
- Fiber optics sensors
- Pulse applications

## OPTIONS

- 20 GHz version
- 1060 nm, 1300 nm band versions

## RELATED EQUIPMENTS

- Pulsed driver DR-PL
- MBC Automatic Bias Controllers

The MXER-LN series of intensity modulators is a family of high performance modulators exhibiting superior Extinction Ratio. Their specific design relies on iXblue "Magic Junction" (patent n° US2008193077).

MXER-LN series intensity modulators are key devices in all applications where a combination of high extinction and high bandwidth is required: laser pulse picking prior optical amplification, pulse generation or lidar based sensing systems are a few examples, as well as fiber optics sensors.

### MXER-LN-10 Performance Highlights

Parameter	Min	Typ	Max	Unit
Operating wavelength	1530	-	1625	nm
Insertion loss	-	3,5	-	dB
Extinction ratio	-	30, 35, 40	-	dB
Electro-optical bandwidth	10	-	-	GHz

Specifications given at 25 °C, 1550 nm

### MXER-LN-20 Performance Highlights

Parameter	Min	Typ	Max	Unit
Operating wavelength	1530	-	1625	nm
Insertion loss	-	3,5	-	dB
Extinction ratio	-	30, 35, 40	-	dB
Electro-optical bandwidth	18	-	-	GHz

Specifications given at 25 °C, 1550 nm

### Extinction Ratio Response

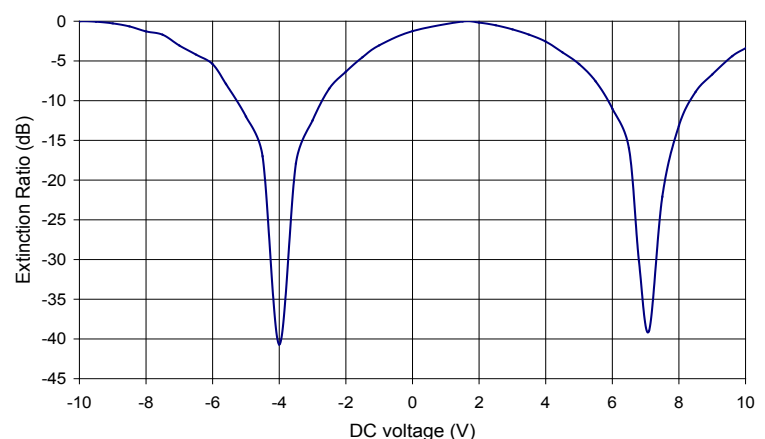

## MXER-LN-10

### 10 GHz Very High Extinction Ratio Intensity Modulator

#### Electrical Characteristics

Parameter	Symbol	Condition	Min	Typ	Max	Unit
Electro-optic bandwidth	$S_{21}$	RF electrodes, from 2 GHz	10	12	-	GHz
Rise / fall times	$t_r / t_f$	Optical pulse, using DR-PL-10-MO	-	30	35	ps
Ripple $S_{21}$	$\Delta S_{21}$	RF electrodes, $f < 12$ GHz	-	0.5	1	dB
Electrical return loss	$S_{11}$	RF electrodes, 0 - 12 GHz	-	-12	-10	dB
$V_{\pi}$ RF @ 50 kHz	$V_{\pi RF_{50\text{ kHz}}}$	RF electrodes, @1550 nm	-	5.5	6	V
$V_{\pi}$ RF @ 10 GHz	$V_{\pi RF_{10\text{ GHz}}}$	RF electrodes, @1550 nm	-	6.5	7	V
$V_{\pi}$ DC electrodes	$V_{\pi DC}$	DC electrodes	-	6.5	7	V
Impedance matching	$Z_{in-RF}$	-	-	50	-	$\Omega$
DC input impedance	$Z_{in-DC}$	-	1	-	-	M $\Omega$

#### Optical Characteristics

Parameter	Symbol	Condition	Min	Typ	Max	Unit
Crystal	-	-	Lithium Niobate X-Cut Y-Prop			
Operating wavelength	$\lambda$	-	1530	1550	1625	nm
Insertion loss	IL	Without connectors	-	3,5	5	dB
DC extinction ratio	ER > 30	Measured at 1550 nm by default, for other $\lambda$ contact us	30	-	-	dB
	ER > 35		35	-	-	dB
	ER > 40		40	-	-	dB
Optical return loss	ORL	-	-40	-45	-40	dB
Chirp	$\alpha$	-	-0.1	0	-0.1	-

All specifications given at 25°C, 1550 nm, unless differently specified

#### Absolute Maximum Ratings

Stresses in excess of the absolute maximum ratings can cause permanent damage to the device. These are absolute stress ratings only. Functional operation of the device is not implied at these or any other conditions in excess of those given in the operational sections of the data sheet. Exposure to absolute maximum ratings for extended periods can adversely affect device reliability.

Parameter	Symbol	Min	Max	Unit
RF input power	$EP_{in}$	-	28	dBm
Bias voltage	$V_{bias}$	-20	+20	V
Optical input power	$OP_{in}$	-	20	dBm
Operating temperature	OT	0	+70	°C
Storage temperature	ST	-40	+85	°C

## MXER-LN-20

### 20 GHz Very High Extinction Ratio Intensity Modulator

#### Electrical Characteristics

Parameter	Symbol	Condition	Min	Typ	Max	Unit
Electro-optic bandwidth	$S_{21}$	RF electrodes, from 2 GHz	18	20	-	GHz
Rise / fall times	$t_r / t_f$	Optical pulse with DR-PL-20-MO	-	20	25	ps
Ripple $S_{21}$	$\Delta S_{21}$	RF electrodes, $f < 18$ GHz	-	0.5	1	dB
Electrical return loss	$S_{11}$	RF electrodes, 0 - 18 GHz	-	-12	-10	dB
$V\pi$ RF @ 50 kHz	$V\pi_{RF_{50\text{ kHz}}}$	RF electrodes, @1550 nm	-	5.5	6	V
$V\pi$ DC electrodes	$V\pi_{DC}$	DC electrodes	-	6.5	7	V
Impedance matching	$Z_{in-RF}$	-	-	50	-	$\Omega$
DC input impedance	$Z_{in-DC}$	-	1	-	-	M $\Omega$

#### Optical Characteristics

Parameter	Symbol	Condition	Min	Typ	Max	Unit
Crystal	-	-	Lithium Niobate X-Cut Y-Prop			
Operating wavelength	$\lambda$	-	1530	1550	1625	nm
Insertion loss	IL	Without connectors	-	3,5	5	dB
DC extinction ratio	ER > 30	Measured at 1550 nm by default, for other $\lambda$ contact us	30	-	-	dB
	ER > 35		35	-	-	dB
	ER > 40		40	-	-	dB
Optical return loss	ORL	-	-40	-45	-40	dB
Chirp	$\alpha$	-	-0.1	0	-0.1	-

All specifications given at 25°C, 1550 nm, unless differently specified

#### Absolute Maximum Ratings

Stresses in excess of the absolute maximum ratings can cause permanent damage to the device. These are absolute stress ratings only. Functional operation of the device is not implied at these or any other conditions in excess of those given in the operational sections of the data sheet. Exposure to absolute maximum ratings for extended periods can adversely affect device reliability.

Parameter	Symbol	Min	Max	Unit
RF input power	$EP_{in}$	-	28	dBm
Bias voltage	$V_{bias}$	-20	+20	V
Optical input power	$OP_{in}$	-	20	dBm
Operating temperature	OT	0	+70	°C
Storage temperature	ST	-40	+85	°C

Typical  $S_{21}$  Curve

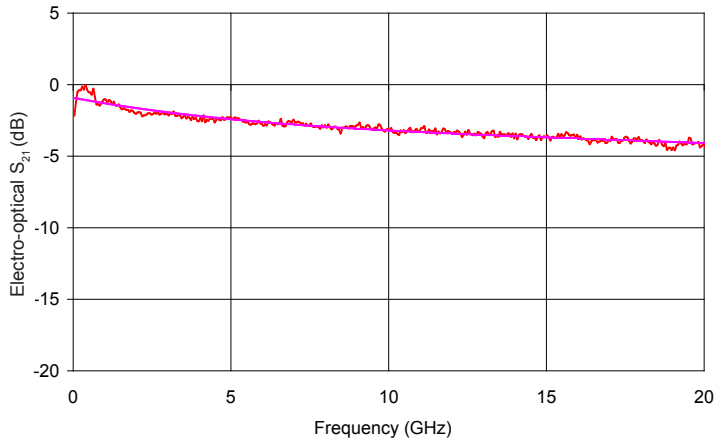

Typical  $S_{11}$  Curve

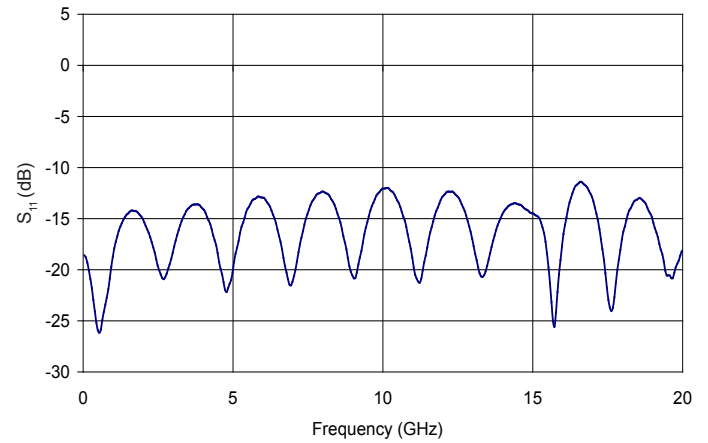

Extinction Ratio

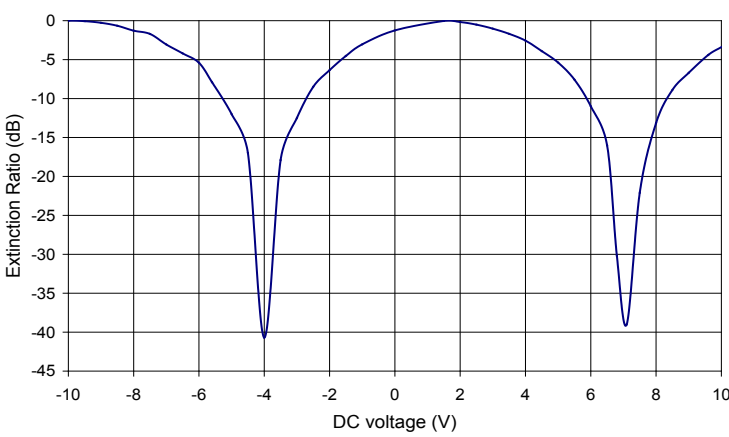

Generated 80 ps Optical Pulse

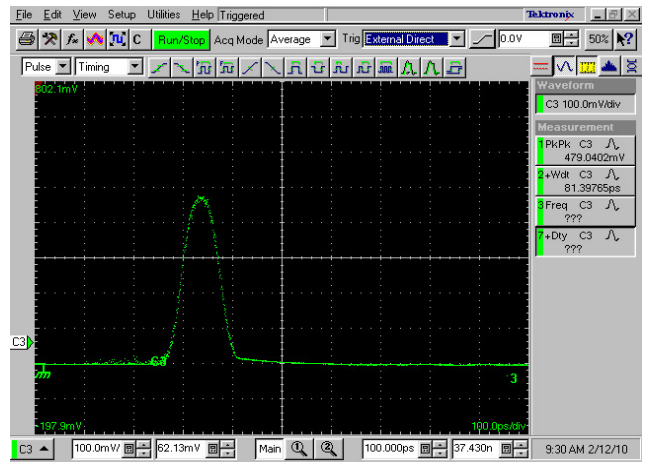

Stability with Time and Temperature

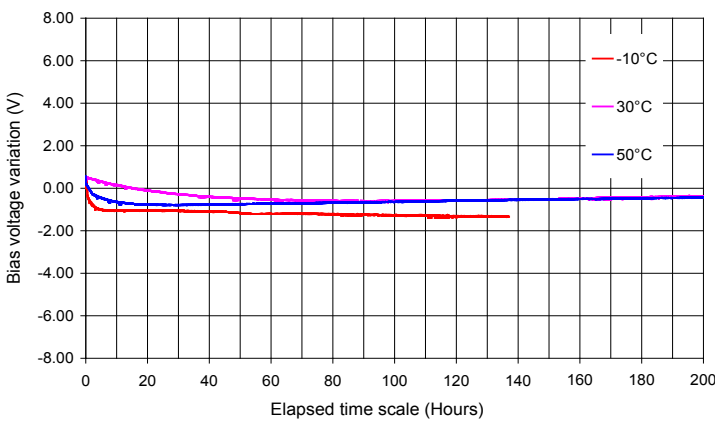

Insertion Loss with Time and Temperature

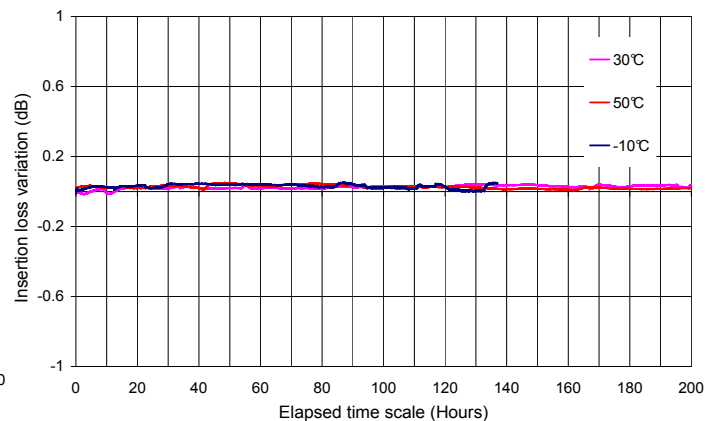

**Mechanical Diagram and Pinout**

All measurements in mm

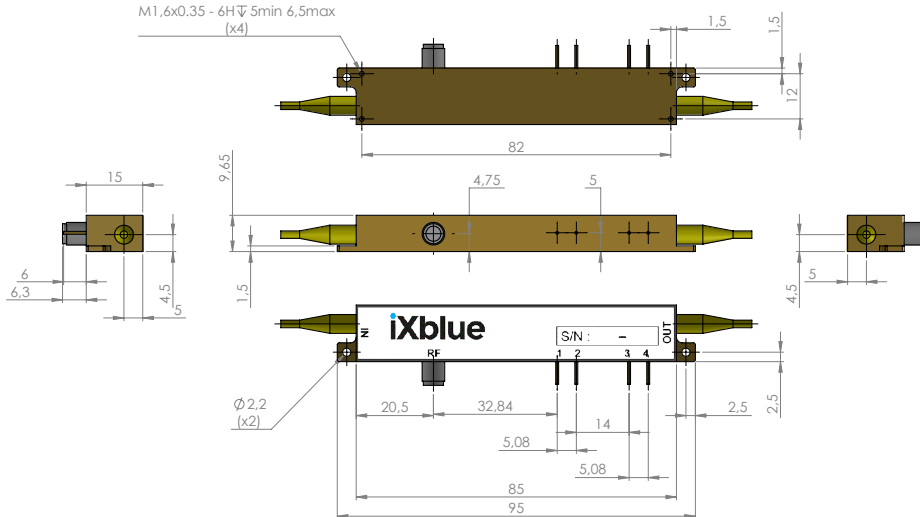

Port	Function	Note
IN	Optical input port	Polarization maintaining fiber, Corning PM 15-U25D, Length 1.5 meter. Buffer diameter 900 mm
OUT	Optical output port	Polarization maintaining fiber, Corning PM 15-U25D, Length 1.5 meter. Buffer diameter 900 mm
RF	RF input port	Wiltron female K (SMA compatible)
1	Ground	Pin feed through diameter 1.0 mm
2	DC	Pin feed through diameter 1.0 mm
3, 4	Photodiode cathode, anode	Pin feed through diameter 1.0 mm

**Ordering information**

**MXER-LN-BW-XX-Y-Z-AB-CD-xxdB**

BW = Bandwidth : 10 10 GHz 20 20 GHz  
 XX = Internal photodiode PD, 00 : Not integrated PD : Integrated  
 Y = Input fiber : P Polarization maintaining S Standard single mode  
 Z = Output fiber : P Polarization maintaining S Standard single mode  
 AB = Input connector : 00 bare fiber FA FC/APC FC FC/SPC  
 CD = Output connector : 00 bare fiber FA FC/APC FC FC/SPC  
 xxdB = Extinction ratio : 30 30 dB - 35 35dB - 40 40dB  
 Note : optical connectors are Senko with narrow key or equivalent

**About us**

iXBlue Photonics produces specialty optical fibers and Bragg gratings based fiber optics components and provides optical modulation solutions based on the company lithium niobate (LiNbO<sub>3</sub>) modulators and RF electronic modules.

iXBlue Photonics serves a wide range of industries: sensing and instruments, defense, telecommunications, space and fiber lasers as well as research laboratories all over the world.

3, rue Sophie Germain  
 25 000 Besançon - FRANCE  
 Tel. : +33 (0) 381 853 180 - Fax : + 33 (0) 381 811 557



Phone: 13020166191  
 Website: www.auniontech.com  
 E-mail: info@auniontech.com