



CinCam CCD - Technical Data -

	CCD-1201	CCD-1301	CCD-2301	CCD-2302
SENSOR DATA				
Format:	1/2"	1/3"	2/3"	2/3"
Active area:	6.5mm x 4.8mm	4.8mm x 3.6mm	9.0mm x 6.7mm	8.5mm x 7.1mm
Number of pixel:	1388 x 1038 (1.4MPixel)	1292 x 964 (1.2MPixel)	1388 x 1038 (1.4MPixel)	2452 x 2056 (5MPixel)
Pixel size:	4.65µm x 4.65µm	3.75µm x 3.75µm	6.45µm x 6.45µm	3.45µm x 3.45µm
Spectral response without cover glass:	(200) 350nm - 1100nm	(200) 350nm - 1100nm	(200) 350nm - 1100nm	(200) 350nm - 1100nm
Laser beam diameter min / max:	46.5µm / 4mm	37.5µm / 3mm	64.5µm / 5mm	34.5µm / 5.5mm
Sensor cooling:	passive	passive	passive	passive
CAMERA FEATURES				
Lens mount:	C-Mount	C-Mount	C-Mount	C-Mount
Bit depth (output):	14Bit	14Bit	14Bit	14Bit
Dynamic:	60dB (1:1000)	59dB (1:900)	67dB (1:2200)	54dB (1:500)
Frame rate:	up to 15Hz	up to 26Hz	up to 16Hz	up to 6Hz
Exposure time:	100µs-1s	100µs-1s	100µs-1s	100µs-1s
Interface:	FireWire 1394b / GigE	FireWire 1394b / GigE	FireWire 1394b / GigE	FireWire 1394b / GigE
I / O connector:	12-Pin Hirose	12-Pin Hirose	12-Pin Hirose	12-Pin Hirose
Mode:	cw or pulsed	cw or pulsed	cw or pulsed	cw or pulsed
Trigger:	TTL-signal	TTL-signal	TTL-signal	TTL-signal
Combinable with:	IR- / UV-Module Beam expander Attenuator	Microscope lens Beam expander Attenuator	Beam expander Attenuator	Beam expander Attenuator
SPECIFICATIONS				
Mechanical dimensions (W x H x L):	60mm x 60mm x 103.8mm	60mm x 60mm x 103.8mm	60mm x 60mm x 103.8mm	60mm x 60mm x 103.8mm
Weight:	300g	300g	300g	300g
Electrical requirements:	DC 8V-36V	DC 8V-36V	DC 8V-36V	DC 8V-36V
Storage temperature*:	-10°C...+60°C	-10°C...+60°C	-10°C...+60°C	-10°C...+60°C
Operating temperature*:	+5°C...+45°C	+5°C...+45°C	+5°C...+45°C	+5°C...+45°C
Regulations:	CE, RoHS	CE, RoHS	CE, RoHS	CE, RoHS

* without condensation

Design and specification of the described product(s) are subject to change without notice.

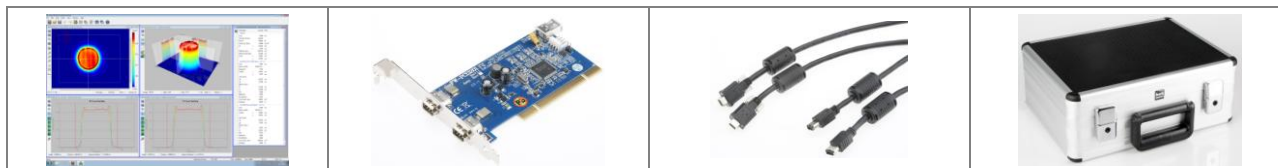

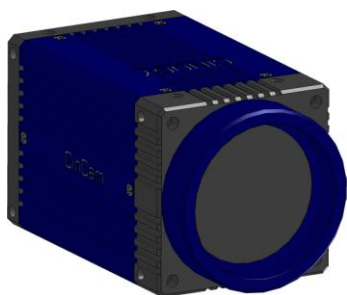

CinCam CCD Large Format - Technical Data -

	CCD-3501	CCD-3502	CCD-1.001	CCD-1.201
SENSOR DATA				
Format:	35mm CCD	35mm CCD	1.0"	1.2"
Active area:	36mm x 24mm	36mm x 24mm	15.2mm x 8.0mm	15.2mm x 15.2mm
Number of pixel:	4008 x 2672 (11MPixel)	4872 x 3248 (16MPixel)	1920 x 1080 (2.1MPixel)	2048 x 2048 (4.2MPixel)
Pixel size:	9.0µm x 9.0µm	7.4µm x 7.4µm	7.4µm x 7.4µm	7.4µm x 7.4µm
Spectral response without cover glass:	(200) 350nm - 1100nm	(200) 350nm - 1100nm	(200) 350nm - 1100nm	(200) 350nm - 1100nm
Laser beam diameter min / max:	90µm / 18mm	74µm / 18mm	74µm / 6.0mm	74µm / 11.0mm
Sensor cooling:	passive	passive	passive	passive
CAMERA FEATURES				
Lens mount:	F-Mount	F-Mount	C-Mount	C-Mount
Bit depth (output):	14Bit	14Bit	14Bit	14Bit
Dynamic:	59dB (1:900)	57dB (1:710)	57dB (1:710)	57dB (1:710)
Frame rate:	up to 2Hz	up to 1.4Hz	up to 15Hz	up to 8Hz
Exposure time:	1ms-1s	1ms-1s	100µs-1s	100µs-1s
Interface:	FireWire 1394b	FireWire 1394b	FireWire 1394b	FireWire 1394b
I / O connector:	12-Pin Hirose	12-Pin Hirose	12-Pin Hirose	12-Pin Hirose
Mode:	cw or pulsed	cw or pulsed	cw or pulsed	cw or pulsed
Trigger:	TTL-signal	TTL-signal	TTL-signal	TTL-signal
SPECIFICATIONS				
Mechanical dimensions (W x H x L):	60mm x 60mm x 114.3mm	60mm x 60mm x 114.3mm	60mm x 60mm x 114.3mm	60mm x 60mm x 114.3mm
Weight:	380g	380g	300g	300g
Electrical requirements:	DC 8V-36V	DC 8V-36V	DC 8V-36V	DC 8V-36V
Storage temperature*:	-10°C...+60°C	-10°C...+60°C	-10°C...+60°C	-10°C...+60°C
Operating temperature*:	+5°C...+45°C	+5°C...+45°C	+5°C...+45°C	+5°C...+45°C
Regulations:	CE, RoHS	CE, RoHS	CE, RoHS	CE, RoHS

* without condensation

Design and specification of the described product(s) are subject to change without notice.

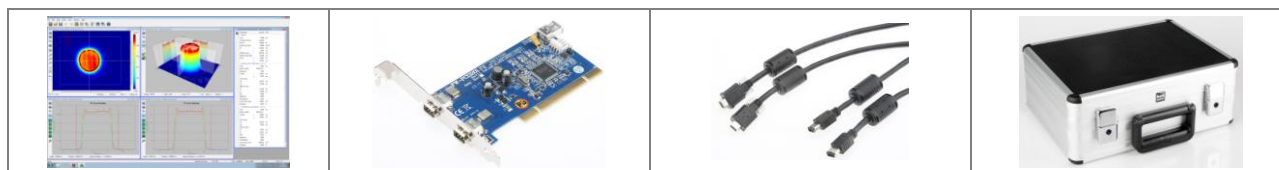



CinCam CCD - Sensor Response - - Dimensions -

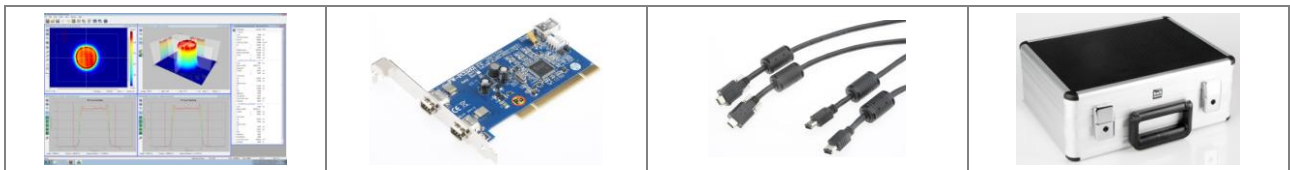
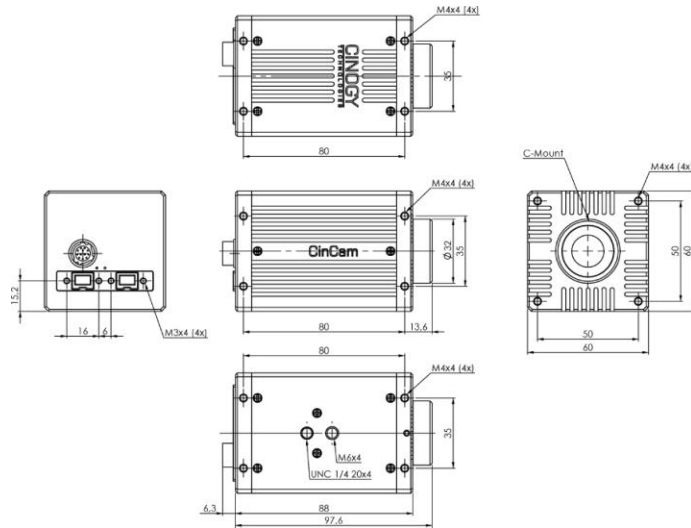
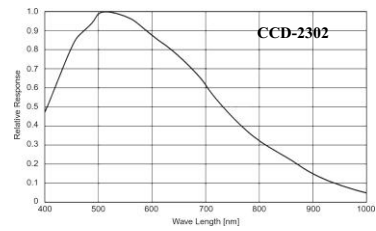
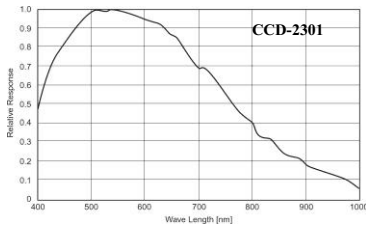
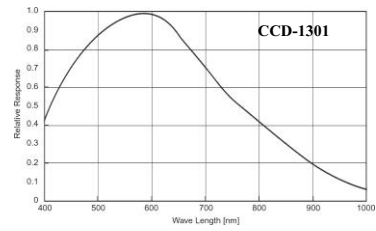
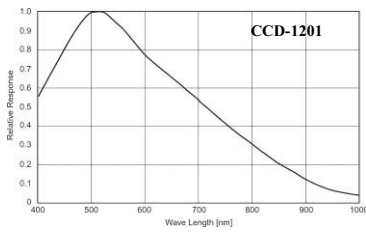



CinCam CCD - Operational Range -

Saturation limit assumes:

Saturation level:	90%
Built-in ND-Filter:	OD3.0
Exposure time:	100µs (lowest value)
Gain:	1 (lowest value)
Maximum beam power:	<1W

A higher power level is possible with additional ND filter:

Optical density	Higher limit
OD 1.0	10 x Saturation limit
OD 2.0	100 x Saturation limit
OD 3.0	1000 x Saturation limit
OD 4.0	10000 x Saturation limit

By longer exposure times a lower power level is apply:

Exposure time	Lower limit	
100µs	See chart for cw saturation limit	
1ms	0.1 x Saturation limit	
10ms	0.01 x Saturation limit	Only for cw laser!
100ms	0.001 x Saturation limit	
1000ms	0.0001 x Saturation limit	

Max. pulse repetition rate / pulse length for single pulse measurement:

See chart for pulse saturation limit

Exposure time	Pulse repetition rate / pulse length	
100µs	10kHz / <100µs	
1ms	1kHz / <1ms	
10ms	100Hz / <10ms	Only for pulsed laser!
100ms	10Hz / <100ms	
1000ms	1Hz / <1000ms	

